



# Application Note: AN\_SYR837/SYR838

## High Efficiency 5.5V, 6A, 2.4MHz I<sup>2</sup>C Programmable, Synchronous Step Down Regulator

### General Description

SYR837/SYR838 is a high efficiency 2.4MHz synchronous step down DC/DC regulator IC capable of delivering up to 6A output currents. It can operate over a wide input voltage range from 2.6V to 5.5V and integrate main switch and synchronous switch with very low R<sub>DS(ON)</sub> to minimize the conduction loss. The output voltage can be programmed from 0.7125V to 1.5V through I<sup>2</sup>C interface.

SYR837/SYR838 is in a space saving, low profile CSP1.56\*1.96-20 package.

### Ordering Information

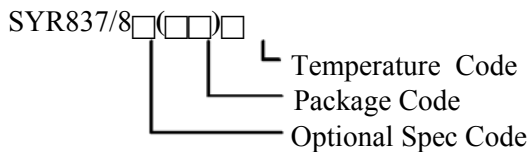

Ordering Number	Package Type	Note
SYR837PKC	CSP1.56*1.96-20	0x40H
SYR838PKC	CSP1.56*1.96-20	0x41H

### Features

- Input voltage range: 2.6V to 5.5V
- 2.4 MHz switching frequency minimizes the external components
- Typical 65uA quiescent current
- Low R<sub>DS(ON)</sub> for internal switches (PFET/NFET): 28mΩ/17mΩ
- Programmable Output Voltage: 0.7125V to 1.5V in 12.5mV steps
- 6A continuous output current capability.
- Capable for 0.25uH inductor and 22uF Ceramic Capacitor.
- Hic-cup mode protection for hard short condition
- RoHS Compliant and Halogen Free
- Compact package: CSP1.56\*1.96-20

### Applications

- Smart-phone
- Web-tablets

### Typical Applications

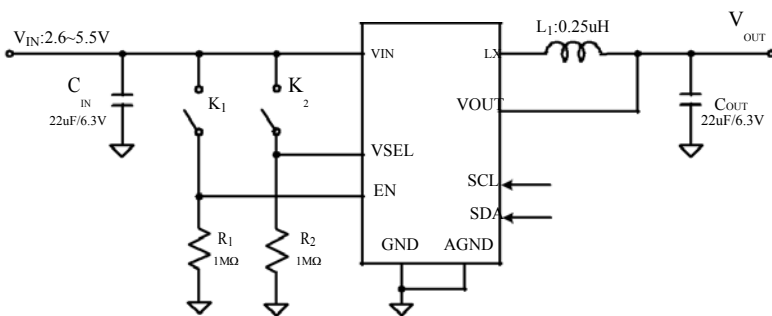

Figure 1. Schematic Diagram

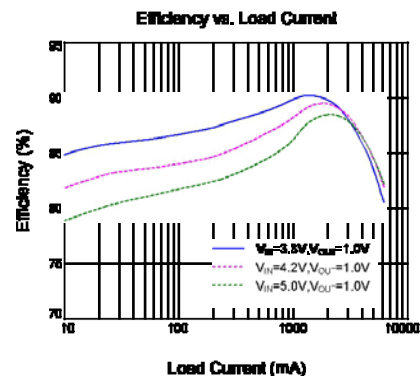
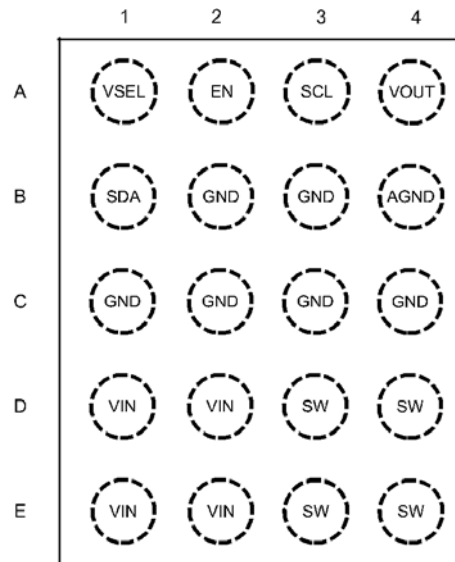

Figure2. Efficiency



# AN\_SYR837/SYR838

## Pinout (top view)



Part Number	Package type	Top Mark
SYR837PKC	CSP1.56*1.96-20	Jn xyz
SYR838PKC	CSP1.56*1.96-20	Jq xyz

Note ① : x=year code, y=week code, z= lot number code.

Pin	Pin Name	Pin Description
D1,D2,E1,E2	VIN	Power input pin. These pins must be decoupled to ground with at least 22uF ceramic capacitor. The input capacitor should be placed as close as possible between VIN and GND pins.
D3,D4,E3,E4	SW	Switching node pin. Connect these pins to the switching node of inductor.
B2,B3,C1,C2,C3,C4	GND	Power ground pins.
A1	VSEL	Voltage select pin. When this pin is low, V <sub>OUT</sub> is set by the VSEL0 register. When this pin is high, V <sub>OUT</sub> is set by the VSEL1 register.
A2	EN	Enable control pin. Active high. Do not leave it floating.
B1	SDA	I <sup>2</sup> C interface Bi-directional Data line.
B4	AGND	Analog ground pin.
A3	SCL	I <sup>2</sup> C interface clock line.
A4	VOUT	Sense pin for output. Connect to the output capacitor side.



# AN\_SYR837/SYR838

## Absolute Maximum Ratings (Note 1)

V <sub>IN</sub> -----	6.0V
All Other Pins-----	V <sub>IN</sub> + 0.6V
Power Dissipation, P <sub>D</sub> @ T <sub>A</sub> = 25°C CSP1.56*1.96-20-----	2.6W
Package Thermal Resistance (Note 2)	
$\theta_{JA}$ -----	38°C/W
$\theta_{JC}$ -----	8°C/W
Junction Temperature Range-----	150°C
Lead Temperature (Soldering, 10 sec.)-----	260°C
Storage Temperature Range-----	-65°C to 150°C

## Recommended Operating Conditions (Note 3)

Supply Input Voltage-----	2.6V to 5.5V
Junction Temperature Range-----	-40°C to 125°C
Ambient Temperature Range-----	-40°C to 85°C



# AN\_SYR837/SYR838

## Electrical Characteristics

( $V_{IN} = 5V$ ,  $V_{OUT} = 1.0V$ ,  $L = 0.25\mu H$ ,  $C_{OUT} = 22\mu F$ ,  $T_A = 25^\circ C$ , unless otherwise specified)

Parameter	Symbol	Test Conditions	Min	Typ	Max	Unit
Input Voltage Range	$V_{IN}$		2.6		5.5	V
$V_{IN}$ UVLO	$V_{UVLO}$	$V_{IN}$ Rising		2.45	2.55	V
$V_{IN}$ UVLO Hysteresis	$V_{UVHYS}$			150		mV
Quiescent Current	$I_Q$	$I_{OUT}=0$ , EN=1, FB=105%* $V_{REF}$		65		$\mu A$
Shutdown Current	$I_{SHDN\_H/W}$	EN=0		0.1		$\mu A$
	$I_{SHDN\_S/W}$	EN= $V_{IN}$ , Buck ENx=0		30		
EN, VSEL, SDA, SCL						
Rising threshold	$V_{IH}$		1.1			V
Falling threshold	$V_{IL}$				0.4	V
$V_{OUT}$ Accuracy	$V_{REG}$	Forced PWM, $V_{OUT}=V_{SEL0}$ , default value	-1.5		+1.5	%
$R_{DS(ON)}$ (P-FET)	$R_{DS(ON)N}$			17		$m\Omega$
$R_{DS(ON)}$ (P-FET)	$R_{DS(ON)P}$			28		$m\Omega$
PMOS peak current limit	$I_{LIM\_PEAK}$		7.5			A
NMOS peak current limit	$I_{LIM\_VALLEY}$		6			A
Internal soft-start time	$t_{SS}$			300		$\mu s$
Min on time				40		ns
Oscillator Frequency	$f_{OSC}$			2.4		MHz
Thermal Shutdown Temperature	$T_{SD}$			150		$^\circ C$
Thermal Shutdown Hysteresis	$T_{HYS}$			15		$^\circ C$
LX node discharge resistor	$R_{DSH}$			150		$\Omega$
Input OVP shutdown	$V_{OVP}$	Rising threshold		6.15		V
		Falling threshold	5.5	5.85		V
Over voltage protection blanking time	$t_{Blanking}$			20		$\mu s$

**Note 1:** Stresses beyond the “Absolute Maximum Ratings” may cause permanent damage to the device. These are stress ratings only. Functional operation of the device at these or any other conditions beyond those indicated in the operational sections of the specification is not implied. Exposure to absolute maximum rating conditions for extended periods may affect device reliability.

**Note 2:**  $\theta_{JA}$  is measured in the natural convection at  $T_A = 25^\circ C$  on a low effective single layer thermal conductivity test board of JEDEC 51-3 thermal measurement standard.

**Note 3:** The device is not guaranteed to function outside its operating conditions.



# AN\_SYR837/SYR838

## Enabling Function

The EN pin controls SYR837/SYR838 start up. EN pin low to high transition starts the power up sequence. If EN pin is low, the DC/DC converter will be turned off.

SYR837/SYR838 allows software to enable of the regulator when EN is HIGH, via the BUCK\_EN bits. BUCK\_EN0 and BUCK\_EN1 are both initialized HIGH in the registers.

Hardware and Software Enable control table.

Pins		Bits		OUTPUT
EN	VSEL	BUCK_EN0	BUCK_EN1	
0	x	x	x	OFF
1	0	0	x	OFF
1	0	1	x	ON
1	1	x	0	OFF
1	1	x	1	ON

## Input Over Voltage Protection Function

When the  $V_{IN}$  exceeds over voltage protection threshold, SYR837/SYR838 will stop switching to protect the circuitry. An internal 20us blanking time helps to prevent the circuit from shutting down due to noise spikes.

## I<sup>2</sup>C Interface

SYR837/SYR838 features an I<sup>2</sup>C interface that allow the HOST processor to control the output voltage achieve the DVS function. The I<sup>2</sup>C interface supports clock speeds of up to 3.4MHz and uses standard I<sup>2</sup>C commands. SYR837/SYR838 always operates as a slave device, and is addressed using a 7-bit slave address followed by an 8<sup>th</sup> bit, which indicates whether the transaction is a read-operation or a write-operation. I<sup>2</sup>C address of the SYR837 is set at the factory to 0x40h, the SYR838 is set to 0x41h..

### START and STOP Conditions:

SYR837/SYR838 is controlled via an I<sup>2</sup>C compatible interface. The START condition is a HIGH to LOW transition of the SDA line while SCL is HIGH. The STOP condition is a LOW to HIGH transition on the SDA line while SCL is HIGH. A STOP condition must be sent before each START condition. The I<sup>2</sup>C master always generates the START and STOP conditions.

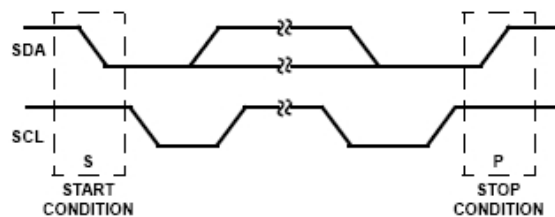

### Data Validity:

The data on the SDA line must be stable during the HIGH period of the SCL, unless generating a START or STOP condition. The HIGH or LOW state of the data line can only change when the clock signal on the SCL line is LOW.

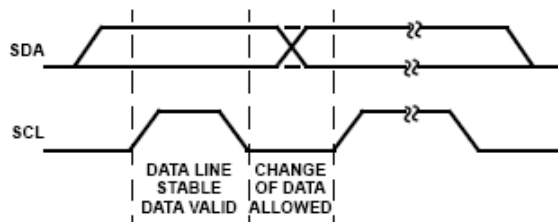



# AN\_SYR837/SYR838

### Acknowledge:

Each address and data transmission uses 9-clock pulses. The ninth pulse is the acknowledge bit (ACK). After the START condition, the master sends 7-slave address bits and an R/ W bit during the next 8-clock pulses. During the ninth clock pulse, the device that recognizes its own address holds the data line low to acknowledge. The acknowledge bit is also used by both the master and the slave to acknowledge receipt of register addresses and data.

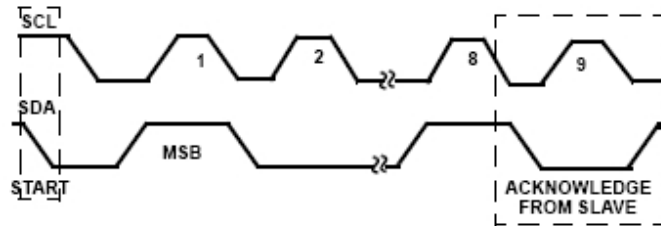

### Data Transactions:

All transactions start with a control byte sent from the I<sup>2</sup>C master device. The control byte begins with a START condition, followed by 7-bits of slave address (1000000x for the SYR837, 1000001x for the SYR838, this address can be changed if necessary) followed by the 8<sup>th</sup> bit, R/ W bit. The R/ W bit is 0 for a write or 1 for a read. If any slave devices on the I<sup>2</sup>C bus recognize their address, they will acknowledge by pulling the SDA line low for the last clock cycle in the control byte. If no slaves exist at that address or are not ready to communicate, the data line will be 1, indicating a Not Acknowledge condition. Once the control byte is sent, and SYR837/SYR838 acknowledges it, the 2nd byte sent by the master must be a register address byte. The register address byte tells the SYR837/SYR838 which register the master will write or read. Once the SYR837/SYR838 receives a register address byte it responds with an acknowledge.

#### Write To A Register



#### Read From A Register





**Register Settings:**

**1. VSEL0 (0x00)**

Register Name				VSEL0
Address				0x00
Field	Bit	R/W	Default	Description
BUCK_EN0	7	R/W	1	Software buck enable. When EN pin is low, the regulator is off. When EN pin is high, BUCK_EN bit takes precedent.
MODE0	6	R/W	0	0=Allow auto-PFM mode during light load. 1=Forced PWM mode
NSEL0	5:0	R/W	010111 (V <sub>OUT</sub> =1.0V)	000000 = 0.7125V 000001 = 0.7250V 000010 = 0.7375V ..... 010111 = 1.0000V ..... 111111 =1.5000V

**2. VSEL1 (0x01)**

Register Name				VSEL1
Address				0x01
Field	Bit	R/W	Default	Description
BUCK_EN1	7	R/W	1	Software buck enable. When EN pin is low, the regulator is off. When EN pin is high, BUCK_EN bit takes precedent.
MODE1	6	R/W	0	0=Allow auto-PFM mode during light load. 1=Forced PWM mode
NSEL1	5:0	R/W	010111 (V <sub>OUT</sub> =1.0V)	000000 = 0.7125V 000001 = 0.7250V 000010 = 0.7375V ..... 010111 = 1.0000V ..... 111111 =1.5000V



## AN\_SYR837/SYR838

### 3. Control Register (0x02)

Register Name				Control Register
Address				0x02
Field	Bit	R/W	Default	Description
Output Discharge	7	R/W	1	0 = discharge resistor is disabled. 1 = discharge resistor is enabled.
Slew Rate	6:4	R/W	000=12.5mV/0.15us	Set the slew rate for positive voltage transitions. 000 = 12.5mV/0.15us 001 = 12.5mV/0.3us 010 = 12.5mV/0.6us 011 = 12.5mV/1.2us 100 = 12.5mV/2.4us 101 = 12.5mV/4.8us 110 = 12.5mV/9.6us 111 = 12.5mV/19.2us
Reserved	3	R/W	0	Always reads back 0.
RESET	2	R/W	0	Setting to 1 resets all registers to default values.
Reserved	1:0	R/W	00	Always reads back 0.

### 4. ID1 Register (0x03)

Register Name				ID1 Register
Address				0x03
Field	Bit	R/W	Default	Description
VENDOR	7:5	R	100	IC vendor Silergy code.
Reserved	4	R	0	Always reads back 0.
DIE_ID	3:0	R	1000	IC option code





## 5. ID2 Register (0x04)

Register Name				ID2 Register
Address				0x04
Field	Bit	R/W	Default	Description
Reserved	7:4	R	0000	Always reads back 0.
DIE_REV	3:0	R	0001	IC mask revision code

## 6. PGOOD Register (0x05)

Register Name				PGOOD Register
Address				0x05
Field	Bit	R/W	Default	Description
PGOOD	7	R	0	1: Buck is enabled and soft-start is completed.
Reserved	6:0	R	000 0000	Always reads back 0.

## Typical Performance Characteristics

Efficiency vs. Load Current

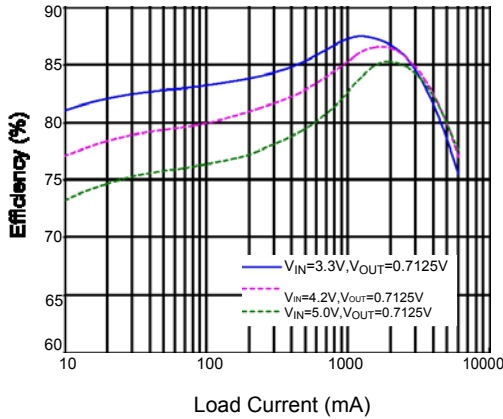

Efficiency vs. Load Current

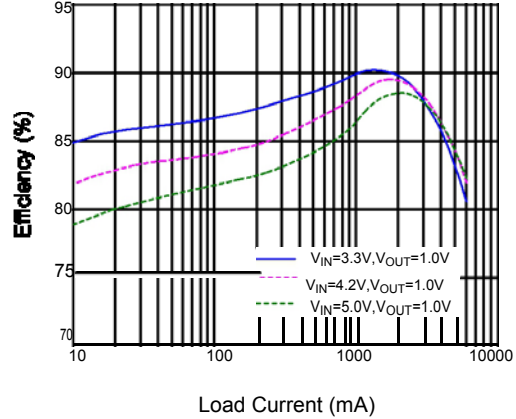

Efficiency vs. Load Current

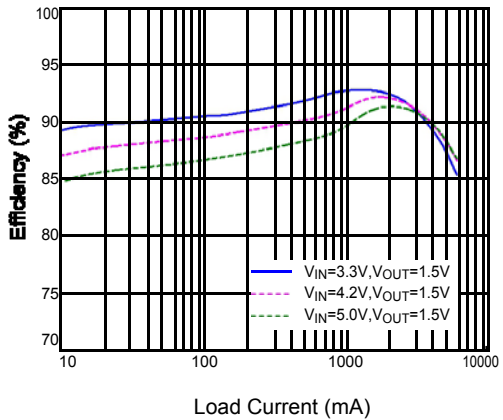

Load Transient  
( $V_{IN}=5.0V, V_{OUT}=1.0V, I_O=0.6 \sim 6.0A$ )

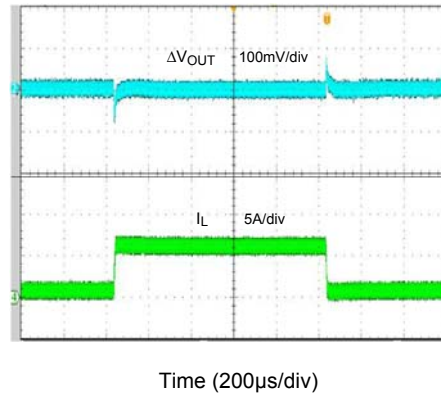

Startup from Enable  
( $V_{IN}=5.0V, V_{OUT}=1.0V, I_O=6.0A$ )

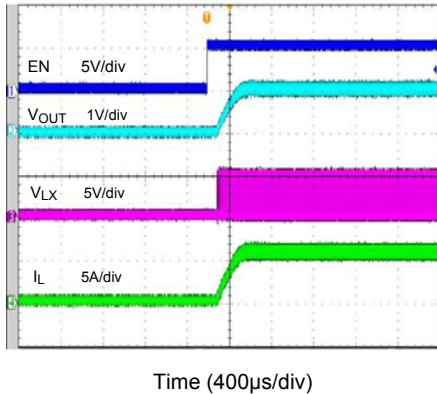

Shutdown from Enable  
( $V_{IN}=5.0V, V_{OUT}=1.0V, I_O=6.0A$ )

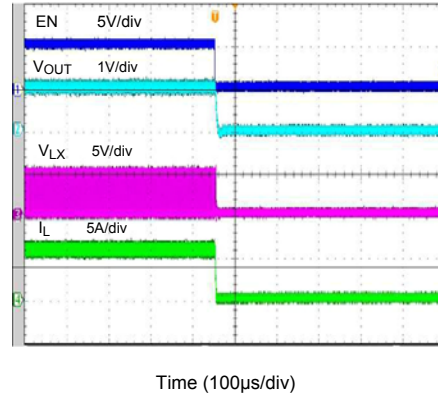



# AN\_SYR837/SYR838

Short Circuit Protection  
( $V_{IN}=5.0V$ ,  $V_{OUT}=1.0V$ ,  $I_O=0A \sim$  short)

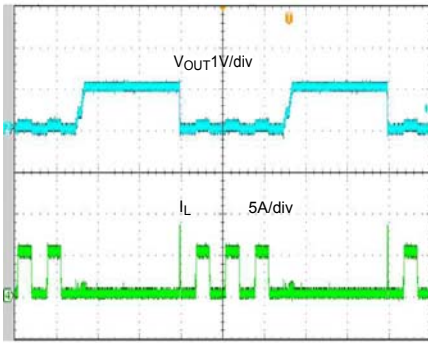

Time (2ms/div)

Short Circuit Protection  
( $V_{IN}=5.0V$ ,  $V_{OUT}=1.0V$ ,  $I_O=6A \sim$  short)

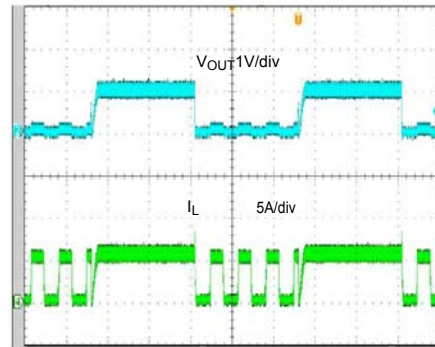

Time (2ms/div)

Dynamic Voltage Switch  
[ $V_{IN}=6.0V$ , 0A Load,  $V_{OUT}=0.7125\sim 1.5V$ , Slow Rate= $12.6mV/0.15\mu s$ ]

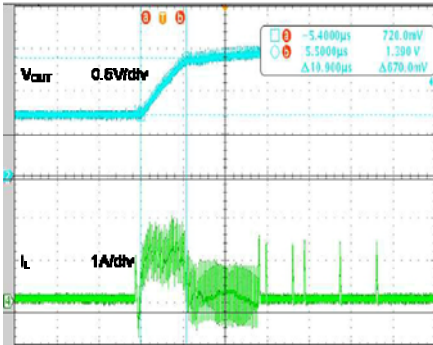

Time (10 $\mu s$ /div)

Dynamic Voltage Switch  
[ $V_{IN}=6.0V$ , 0A Load,  $V_{OUT}=0.7125\sim 1.5V$ , Slow Rate= $12.6mV/19.2\mu s$ ]

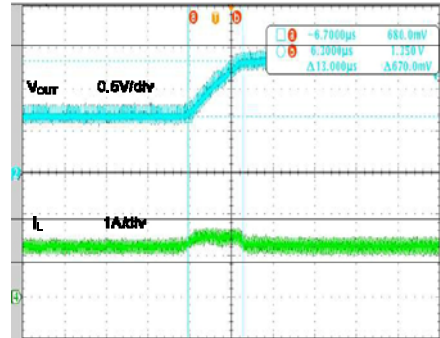

Time (400 $\mu s$ /div)

Dynamic Voltage Switch  
[ $V_{IN}=6.0V$ , 8A Load,  $V_{OUT}=0.7125\sim 1.5V$ , Slow Rate= $12.6mV/0.15\mu s$ ]

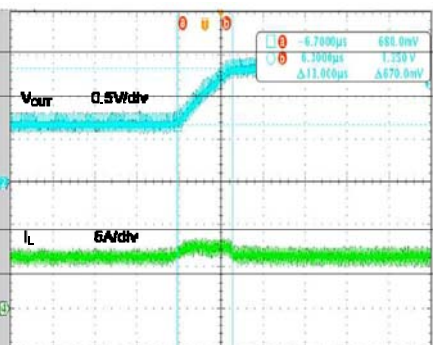

Time (10 $\mu s$ /div)

Dynamic Voltage Switch  
[ $V_{IN}=6.0V$ , 8A Load,  $V_{OUT}=0.7125\sim 1.5V$ , Slow Rate= $12.6mV/19.2\mu s$ ]

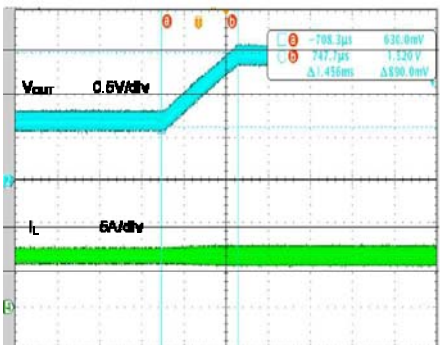

Time (800 $\mu s$ /div)



# AN\_SYR837/SYR838

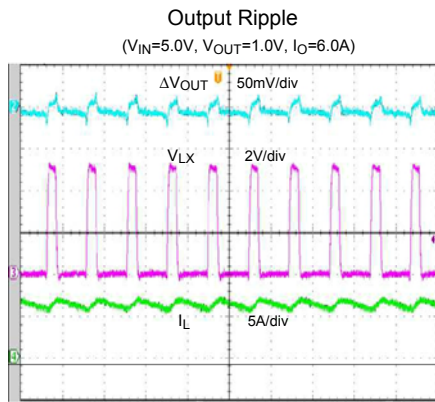

Time (400ns/div)



# AN\_SYR837/SYR838

## Operation

SYR837/SYR838 is a high efficiency 2.4MHz synchronous step down DC/DC regulator IC capable of delivering up to 6A output currents. It can operate over a wide input voltage range from 2.6V to 5.5V and integrate main switch and synchronous switch with very low  $R_{DS(ON)}$  to minimize the conduction loss. The output voltage can be programmed from 0.7125V to 1.5V through I<sup>2</sup>C interface.

## Applications Information

Because of the high integration in SYR837/SYR838, the application circuit based on this regulator IC is rather simple. Only input capacitor  $C_{IN}$ , output capacitor  $C_{OUT}$ , inductor L need to be selected for the targeted applications.

### Input capacitor $C_{IN}$

This ripple current through input capacitor is calculated as:

$$I_{CIN\_RMS} = I_{OUT} \sqrt{D} \times \sqrt{1-D} \quad (A)$$

This formula has a maximum at  $V_{IN}=2 \times V_{OUT}$  condition, where  $I_{CIN\_RMS}=I_{OUT}/2$ .

With the maximum load current at 6A, a typical X5R or better grade ceramic capacitor with 6.3V rating and greater than 22uF capacitance can handle this ripple current well. To minimize the potential noise problem, place this ceramic capacitor really close to the VIN and GND pins. Care should be taken to minimize the loop area formed by  $C_{IN}$ , and VIN/GND pins.

### Output capacitor $C_{OUT}$

Both steady state ripple and transient requirements must be taken into account when selecting this capacitor. For the best performance, it is recommended to use X5R or better grade ceramic capacitor with 6.3V rating and more than one 22uF capacitor.

### Output inductor L:

There are several considerations in choosing this inductor.

- 1) Choose the inductance to provide the desired ripple current. It is suggested to choose the ripple current to be about 40% of the maximum

average input current. The inductance is calculated as:

$$L = \frac{V_{OUT} (1 - V_{OUT}/V_{IN\_MAX})}{F_{SW} \times I_{OUT\_MAX} \times 40\%} \quad (H)$$

where  $F_{SW}$  is the switching frequency and  $I_{OUT\_MAX}$  is the maximum load current.

SYR837/SYR838 is less sensitive to the ripple current variations. Consequently, the final choice of inductance can be slightly off the calculation value without significantly impacting the performance.

- 2) The saturation current rating of an inductor must be selected to guarantee an adequate margin to the peak inductor current under full load conditions.

$$I_{SAT, MIN} > I_{OUT, MAX} + \frac{V_{OUT} (1 - V_{OUT}/V_{IN\_MAX})}{2 \cdot F_{SW} \cdot L}$$

- 3) The DCR of the inductor and the core loss at the switching frequency must be low enough to achieve the desired efficiency requirement. It is desirable to choose an inductor with

$DCR < 15m\Omega$  to achieve a good overall efficiency.

### Layout Design:

To achieve a higher efficiency and better noise immunity, following components should be placed close to the IC:  $C_{IN}$ , L,  $C_{OUT}$ .

- 1) It is desirable to maximize the PCB copper area connecting to GND pin to achieve the best thermal and noise performance. Reasonable vias are suggested to be placed underneath the ground pad to enhance the soldering quality and thermal performance

- 2) The decoupling capacitor of VIN and GND must be placed close enough to the pins. The loop area formed by the capacitors and GND must be minimized.

- 3) The PCB copper area associated with SW pin must be minimized to improve the noise immunity.

- 4) The feedback trace connecting  $C_{OUT}$  to the VOUT pin must NOT be adjacent to the SW node on the PCB layout to minimize the noise coupling to VOUT pin.

PCB Layout Suggestion

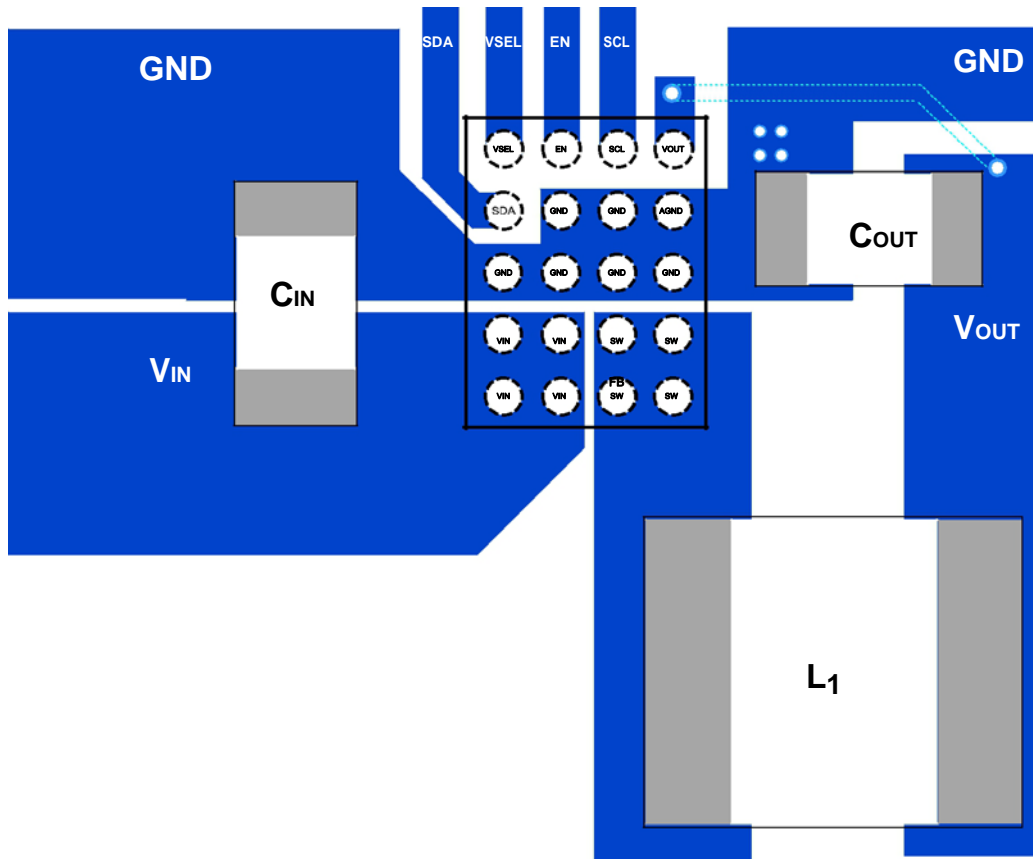



CSP1.56\*1.96-20 Outline Drawing

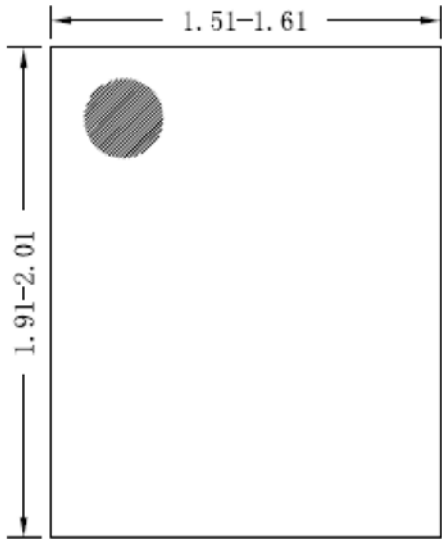

Top View

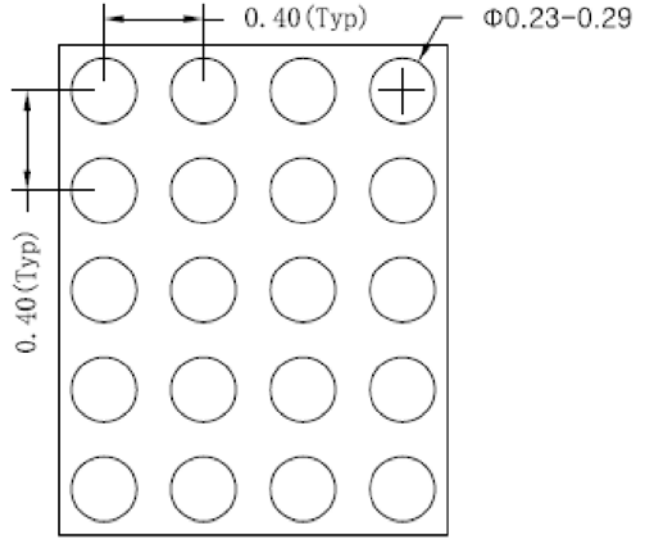

Bottom View

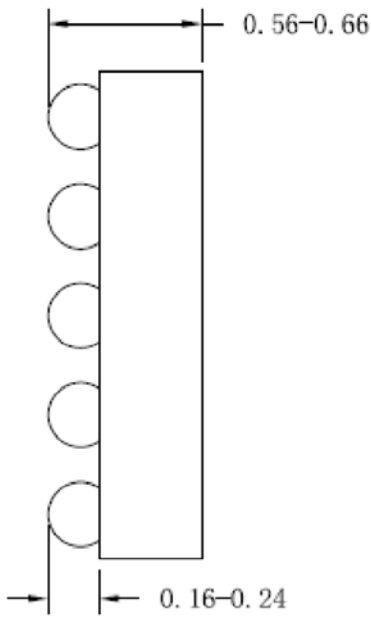

Side View

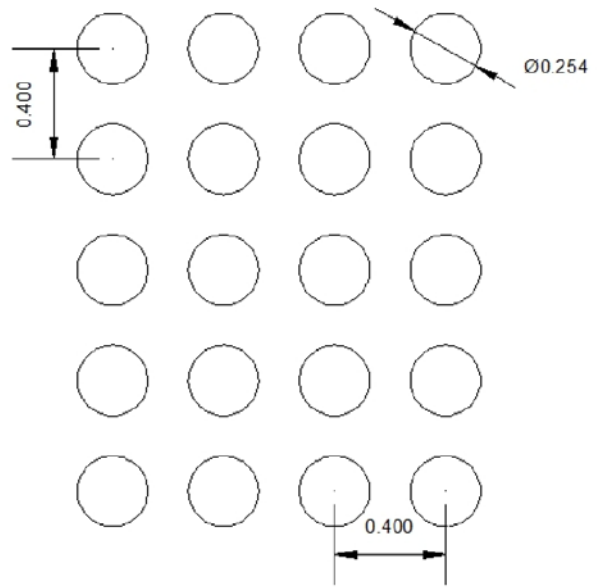

Recommended PCB layout  
(Reference only)

Notes: All dimension in MM and exclude mold flash & metal burr

**Taping & Reel Specification**

**1. CSP1.56\*1.96**

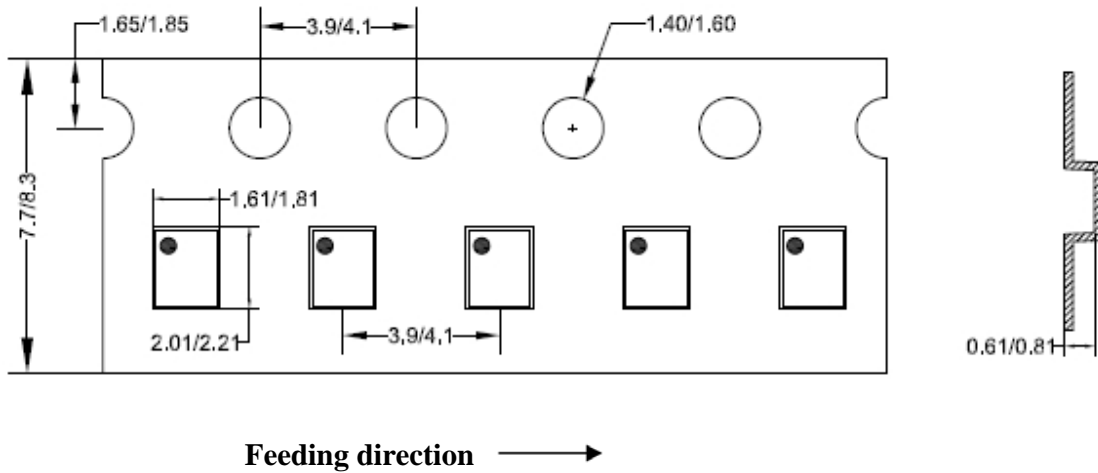

**2. Carrier Tape & Reel specification for packages**

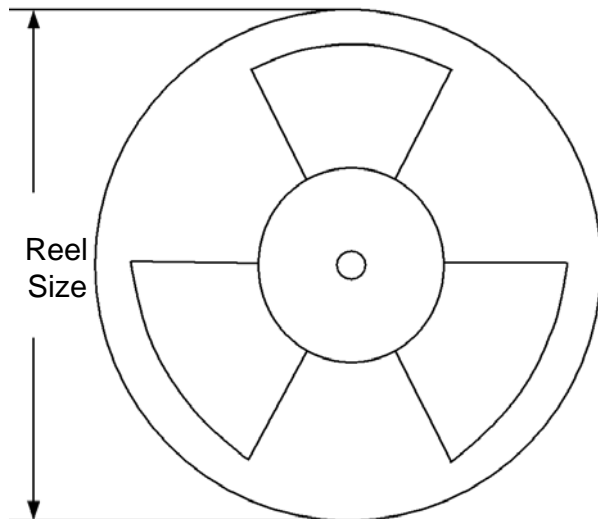

Package types	Tape width (mm)	Pocket pitch(mm)	Reel size (Inch)	Trailer * length(mm)	Leader * length (mm)	Qty per reel (pcs)
CSP1.56*1.96	8	4	7"	400	400	3000

**3. Others: NA**